

A marine meteorological data acquisition system

R.G. PRABHU DESAI, E. DESA and G.VITHAYATHIL

National Institute of Oceanography, Dona Paula, Goa - 403 004, India.

Abstract - A marine meteorological data acquisition system has been developed for long term unattended measurements at remote coastal sites, ocean surface platforms and for use on board research vessels. The system has an open and modular configuration and was interfaced to a variety of sensors to assess relative performance of vector averaged winds, gusts, air temperature and barometric pressure. The inter-comparison of field data obtained from various sensors and their laboratory calibration were carried out to examine their performance. The results showed that adequately sampled and vector averaged winds recorded by Aanderaa and Young sensor were in good agreement. Their energy density spectra showed a close match although overspeeding upto 10% was observed for Aanderaa sensor depending on the turbulence level. The barometric pressure sensor tested of the capacitive type with temperature compensation proved more reliable and accurate than the sensor using strain gauge principle. All temperature sensors tallied within $\pm 0.2^\circ$ C. The system uses semiconductor memory for data storage and supports ARGOS and VHF links for data transmission.

INTRODUCTION

Surface meteorological measurements are of great importance to oceanographers to permit determination of wind stresses, heat fluxes, drag coefficients and for various studies related to air-sea interaction, upper ocean dynamics and coastal upwelling. Meteorological measurements are required to establish ground truth for remotely sensed satellite data, design of offshore structures and coastal beach erosion studies.

Various meteorological data acquisition systems (MDAS) had been developed in the past, at the National Institute of Oceanography, Goa to cater to different needs. The first meteorological station was installed at Antarctica in early 1981. The station recorded data on cassette tape at synoptic intervals for six months during the winter season. The system was designed to work at low temperatures using military grade components (DESA *et al* 1983).

The second system was developed in 1983, for use on an oceanographic data buoy, for air-sea interaction studies (SELVAM 1986). The buoy had a wave transparent structure and supported a 10 meter mast for meteorological measurements. Ten minute averages of surface meteorological data along with water temperature and buoy heading were recorded hourly. The data was recorded on EPROMs.

A third meteorological system was designed for ship-board ground truth remotely sensed satellite data (PRABHU DESAI *et al* 1986). The system recorded ship's position, speed and heading in addition to meteorological parameters to compute true vector winds.

A review in 1986 of possible enhancements to the data acquisition system in view of previous experience and the subsequent advent of low power microelectronics, showed ample scope for new development. Commercially available data loggers were difficult to connect to different type of sensors and although they had good programmability they were not versatile enough to implement software requirements of data acquisition and processing. An access to microprocessor level hardware and software was therefore desired for an efficient system design.

SYSTEM FEATURES

Wide spread use of automatic weather stations is envisaged for coastal and oceanographic studies. The emphasis has been to build a simple system that could be easily configured for different requirements. The system was designed to incorporate the following features.

The hardware structure is modular. Necessary modules are integrated to meet requirements of specific application. A system could be implemented with a minimum of two modules containing a CPU board and a sensor interface board. Optional modules such as additional RAM or EPROM storage or additional sensors could be added for a desired configuration.

The system has a flexible architecture to accommodate different sensors, display and storage options selected on the basis of engineering compromises between cost and performance tradeoffs. The electronics unit usually forms a fractional cost of the sensors and peripheral devices and well designed hardware and software with built in flexibility allows its use in various applications as illustrated in this paper.

Unattended measurements over extended periods of time required system power consumption to be minimal. The use of low power CMOS microprocessor family components drastically reduced the system power supply requirements of the electronics unit. The main sources of power drain are now the sensors rather than data logging electronics.

Use of low power VLSI components and dense packing reduced size and weight of the electronics unit making the system more compact and reliable. An RS-232 link facilitates on-site programming, system checks and data retrieval either by a portable computer or a hand held display terminal.

SYSTEM DESIGN

The system design is based on an eight bit CMOS microprocessor 80c85. The schematic block diagram is shown in Figure 1. The processor and sensor interface modules form the basic configuration. The system supports optional data storage and additional sensors through parallel peripheral interface (PPI) while the CPU bus facilities further expansion.

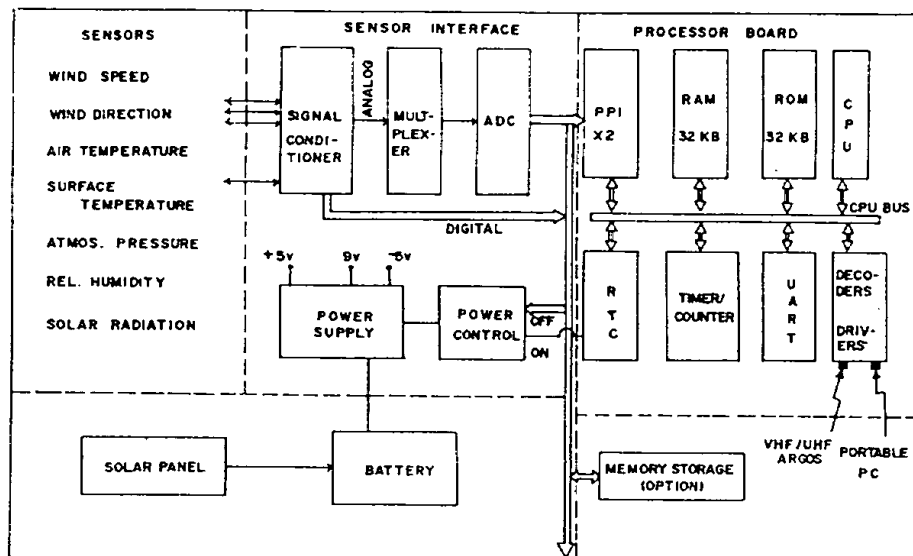

Fig. 1. Block schematic diagram of meteorological data acquisition system.

The processor board has 32k byte memory each for program and data. Other devices on board include a serial RS-232 interface, programmable timer counter, two programmable peripheral interfaces (PPI) and a real time clock (RTC).

The sensors are connected through appropriate signal conditioning circuits to the sensor interface board. The sensor interface is connected to the processor through the PPI. The board contains a 12 bit analog to digital converter (ADC), a 16 channel multiplexer, a precision reference source with buffered outputs, micropower regulator and power control circuit. The ADC can be configured for different ranges and for single or differential input operation.

The analog type sensors are excited by a buffered precision reference source and their half bridge potentiometric outputs are directly connected to the multiplexer, whereas the digital sensors are connected through level shifting circuits to parallel port lines.

The sensor interfaces supports wind speed, wind direction, air temperature, water surface temperature, barometric pressure, humidity and solar radiation sensors. On board health monitoring parameters include reference and battery voltages. Four unassigned analog channels can accommodate additional sensors with analog outputs.

The sensor interface module is connected to the processor through one PPI adapter and the second PPI is used to adapt different data storage options such as tape recorder, CMOS static RAMs and EPROMs or additional sensors. An EPROM storage option that supports a total of 256k byte storage using 8 EPROMs was largely used with this model. At an hourly recording interval an EPROM cassette can hold data for more than ten months of unattended operation. However with the recent availability of laptop PCs for on site data retrieval, CMOS RAMs seem to be more attractive than EPROMs. The system design also supports a VHF radio and ARGOS satellite transmission link.

The system works on a 16 volt power supply. The current drain of the electronics unit is about 15 mA and when the sensors are powered the total current drain goes upto 60 mA depending on the type of sensors connected. The average current drain is therefore dependent on the selected sampling and averaging intervals. The power drain could be further reduced by programming the processor to switch off its power supply and to wake up on a standby interrupt from the RTC.

Rechargeable sealed lead acid batteries are used to provide a 16 volt output supply using 8 cells of 20Ahr capacity. The batteries are charged using solar panels. The batteries themselves could power up the station under no sunlight conditions for approximately 15 days.

The data acquisition software is written in PLM-80. The system is programmed for starting time, sampling and averaging intervals at the beginning of the data acquisition. The processor waits for a programmed warm-up time to permit the sensor stabilization time and then initiates a measurement cycle. All sensor outputs are sampled and their values are computed in terms of engineering units by solving non-linear sensor equations. The vector components of winds are computed, and maximum and minimum values and totals are updated. The averages are computed and stored at predefined intervals. The data is dumped at the end of a measurement cycle on to a serial port for visual inspection using a display terminal or a portable computer. A down load command issued through a serial port can retrieve the entire dataset collected by the system.

The system has been used in different configurations for various studies, viz as a wind recorder for wind energy estimation, atmospheric diffusion studies and ship borne meteorological data collection.

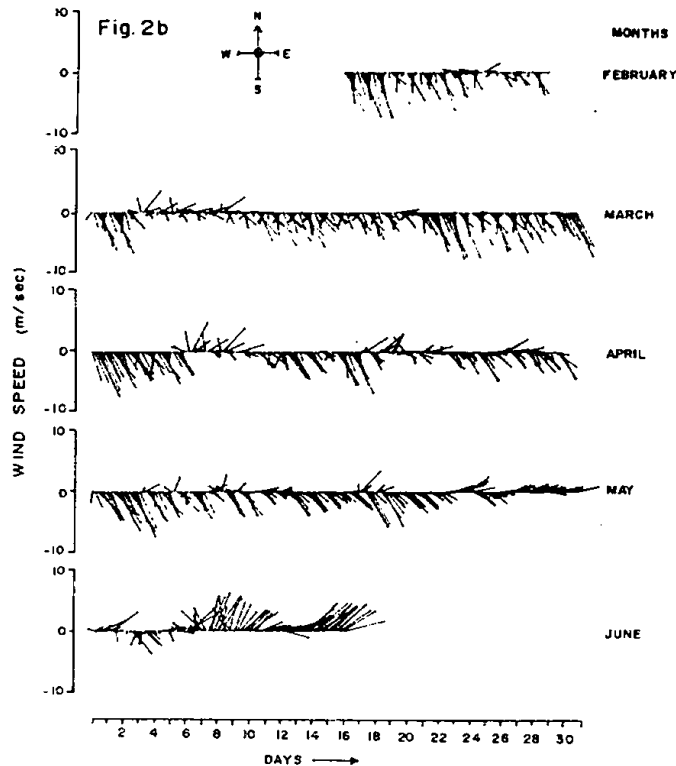
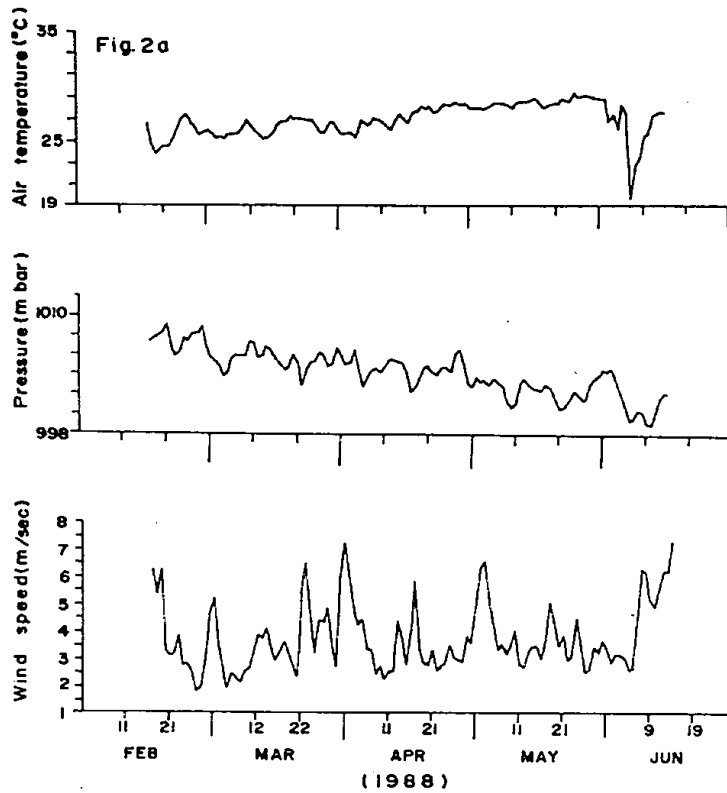

Fig. 2a. Temperature, barometric pressure and wind speed recorded using meteorological data acquisition system near a coastal site off Goa.

Fig. 2b. Stick plot of (4 hour average) winds recorded by meteorological data acquisition system installed off Goa.

Figure 2 shows plots of various parameters collected at a coastal site off Goa. The sensors were mounted on a 10 meter mast above a flat terrain, approximately 200 meters from the coast line. The plots represents data collected over 120 days. The average wind speed during the entire period was 4 m/s. The mean wind direction has been from the north west before the onset of monsoon in June and then from the southwest. The air temperature varied from 19 to 30° C. and the air pressure from 1000 to 1010 mbar.

SENSORS AND INTERCOMPARISON

We have used an Aanderaa suite of sensors as several Aanderaa Weather Stations were being used at the Institute for marine meteorological measurements and spare sensors were readily available. The claimed sensor specifications met our design goals. However laboratory calibrations, field tests and use with our data logger have revealed performance limitations of these sensors. This exercise lead us to look for better sensors for use on our databuoy under development. In the following section details and intercomparison of various sensors used with the meteorological data acquisition system are presented. The intercomparison of Aanderaa and R.M. Young wind sensor is discussed in detail highlighting the sources of errors due to inertial overspeeding, non-cosine vertical response and undersampling. The offsets, drifts and hysteresis observed with the pressure transducers are also presented with a brief mention of the temperature and humidity sensors.

Winds

Two types of sensors viz Aanderaa cup and vane anemometer and R.M. Young propeller model 5103 have been used. The details of the sensors, the sampling scheme and possible sources of measurement errors, and intercomparison of field tests of the two sensors are discussed here.

Aanderaa Sensor: Aanderaa wind speed sensor consists of a 3 cup rotor. The sensor has a magnet and a reed switch assembly to sense the rotations and a built-in averaging circuit that operates over the averaging intervals from 8 seconds to 3 hours. The direction sensor uses a damped vane. The vane is magnetically coupled to a compass coil and is energized by a voltage signal which latches the arm on a pivoted magnet on to a potentiometer track. After the measurement the compass coil is de-energized and the follower magnet is free to rotate. The life time of a potentiometer track is thereby improved as there is no continuous contact of the arm with the track, however the fastest sampling rate is limited to once every few seconds. The highest sampling rate was limited to once every 10 seconds in our applications.

R.M. Young Propeller Model 5103 sensor: This sensor consists of an integrated vane and propeller in one unit and is easier to operate than the separate cup anemometer and vane configuration. The sensor uses a 18 cm diameter 4 blade helicoid propeller molded from polypropylene. The sensor was originally developed for use on ocean data buoys and is accurate and rugged, in addition to being light weight and corrosion resistant. The sensor uses sealed bearings and a linear potentiometer for direction sensing. A six pole magnetic disc attached at the end of the propeller induces an AC signal in the coil of a frequency proportional to the wind speed. The sensor produces 3 sinusoidal pulses for each rotation of the sensor. The vane position is transmitted by a 10K precision conductive-plastic potentiometer.

For inter-comparison experiments Aanderaa and Gill propeller sensors were mounted on the same mast. Wind speed and direction data were logged from the two sensors every 10 seconds. For Aanderaa sensors the average value of the wind speed

and single direction measurement in the 10 second interval was used. In the case of a Young propeller the sinusoidal pulse output after proper signal conditioning was used to interrupt the data logger. The CPU on interrupt reads the instantaneous vane direction and updates the sum of sine and cosine components. At the end of the 10 second interval, vector averaged wind speed and direction were computed. The 10 second averages of the two sensors were dumped on a RS-232 line and a portable battery operated PC was used to log the data. This data was used in the intercomparison analysis.

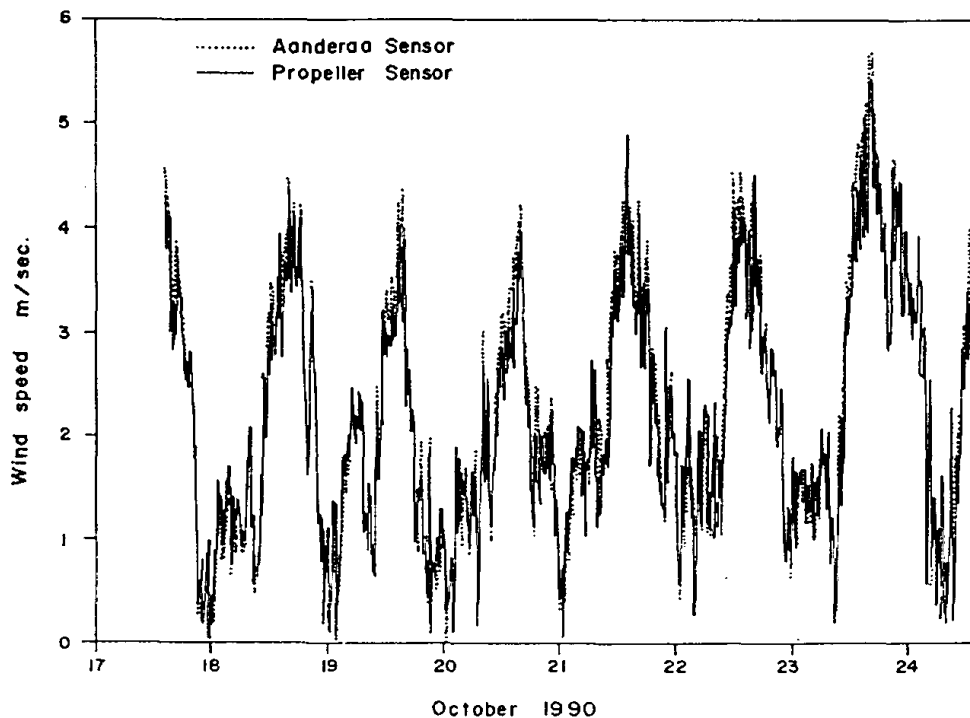

Fig. 3. Plot of 10 minutes vector averaged wind speed from Aanderaa and Young anemometers.

Figures 3 and 4 shows the time series and scatter plots of 10 minute averages of the Aanderaa and Young propeller sensor recorded over a period of two weeks. It is seen that the Aanderaa cups show slightly higher values compared to the propeller output. The average wind recorded over a period of 2 weeks in this set were 3.89 & 3.69 m/sec for cup and propeller respectively showing a difference of 0.2 m/sec or a 5.5% overspeeding of the cups. In another set the average winds recorded over a period of 8 hours were 7.5 & 6.8 m/sec for cup and propeller sensor respectively. A 10% overspeeding of cups was observed in this data set. The overspeeding of cup anemometers is well known. Cup anemometers although exhibiting good calibration and linearity in wind tunnel tests are known to suffer from problems of overspeeding due to inertia and noncosine angular response. The overspeeding of cup anemometers has been reported by various investigators. WELLER et al (1983) report an overestimation of 10% of VAWR (Vector Averaging Wind Recorder) cup anemometers and of 7% for AWR (Aanderaa Wind Recorder) when mounted on a buoy. The overspeeding due to inertia is largely reduced by using lighter cups or by reducing the sensor distance constant. The distance constant of VAWR sensor for instance was 15m and the distance constant for Aanderaa cups is reported to be 5m. The overspeeding due to inertia

may not be as significant for the ocean surface as on land, where the level of turbulence is lower by a factor of 4 to 6. FREITAG *et al* (1988) report comparisons of equatorial winds measured by cup anemometers and propeller anemometers on buoys to agree well with mean differences of 0.1 m/sec.

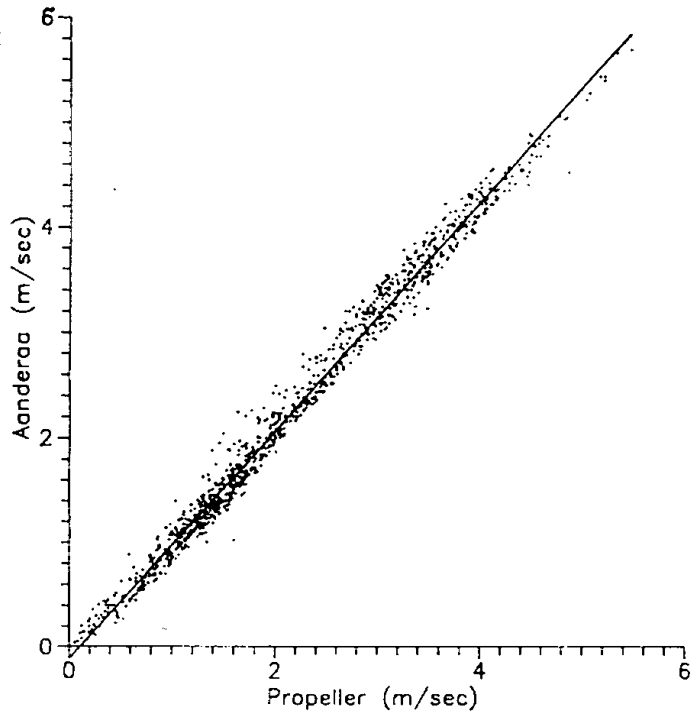

Fig. 4. Scatter plot of wind speed recorded using Aanderaa (cup) and Young (propeller) Anemometers.

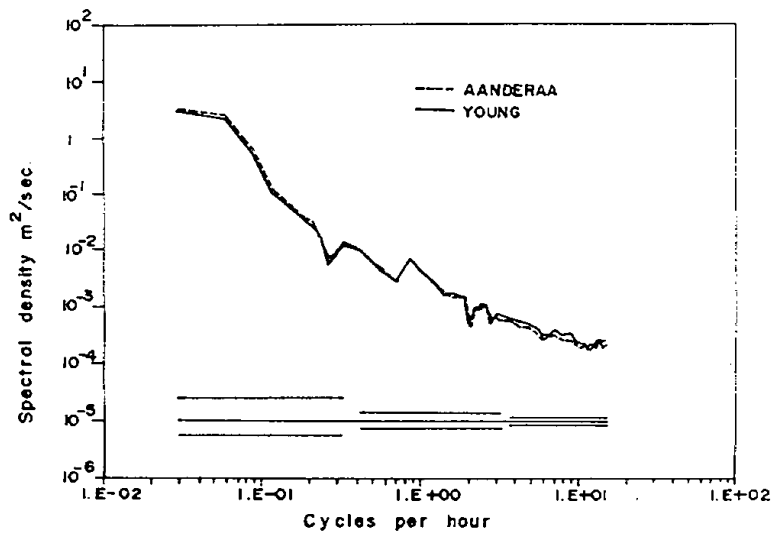

Fig. 5a. Energy density spectra of u component of wind velocity recorded over 10 days period. The energy densities are band averaged and 90% confidence limits are shown.

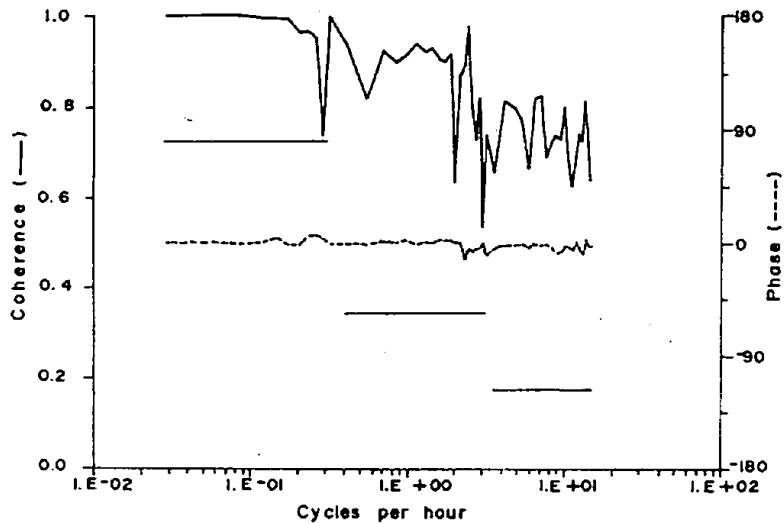

Fig. 5b. Phase & coherence spectra of u component of wind velocity. Horizontal lines show 0.05 significance levels.

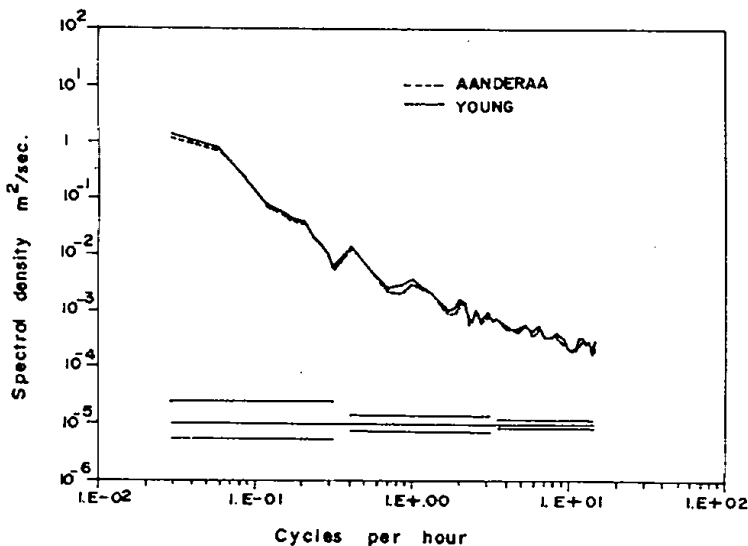

Fig. 6a. Energy density spectra of v component of wind velocity recorded over 10 days period. The energy densities are band averaged and 90% confidence limits are shown.

The second factor contributing to overspeeding of the Aanderaa sensor is due to under sampling of direction and scalar averaging. A velocity proportionate sampling typically will collect about 1000 samples of direction for winds of 10m/s, in the 10 second interval as against a single measurement of direction for Aanderaa sensor. The scalar wind speed averaged over a period of

10 seconds, as from an Aanderaa sensor, will therefore register a higher value to a vector averaged wind over the same interval.

The third factor contributing to the overestimate is the non-cosine response of the cups. Cup anemometers record a higher horizontal velocity than the actual cosine component. The vertical component w in wind will therefore register higher values in cup anemometers. Although the w component is generally much smaller than horizon-

tal component of wind, the contribution may be significant under strongly convective conditions. Local sites can also produce apparent effects for example a wind measured upstream of a hill will have a larger w component, compared to winds over a flat terrain. The noncosine response will be larger at sea due to platform motions.

WELLER *et al* (1983) reported the intercomparison of spectral energy density of winds from different wind recorders used on the buoys during the JASIN experiment. Their results showed an over-estimate of energy densities by a factor of 20 or more at the high frequency end for Aanderaa wind recorders compared to VAWR and other recorders. This overestimate was attributed to in- frequent sampling of wind direction resulting in aliasing from high frequency components present in the data set. In contrast, spectral energy densities in our experiment showed a close match over the entire range of frequencies. A sampling of direction every 10 seconds and computation of vector averages over selected intervals (1- 20 minutes), instead of a single measurement of direction have eliminated this problem of overestimation at high frequencies associated with Aanderaa Wind recorders. Figures 5a and 6a shows the spectral energy densities of u and v wind components for the two sensors. The energy densities computed for both sensors show a close match over the computed frequency spectrum. The phase difference between the wind components at all frequencies has been within 15 degrees.

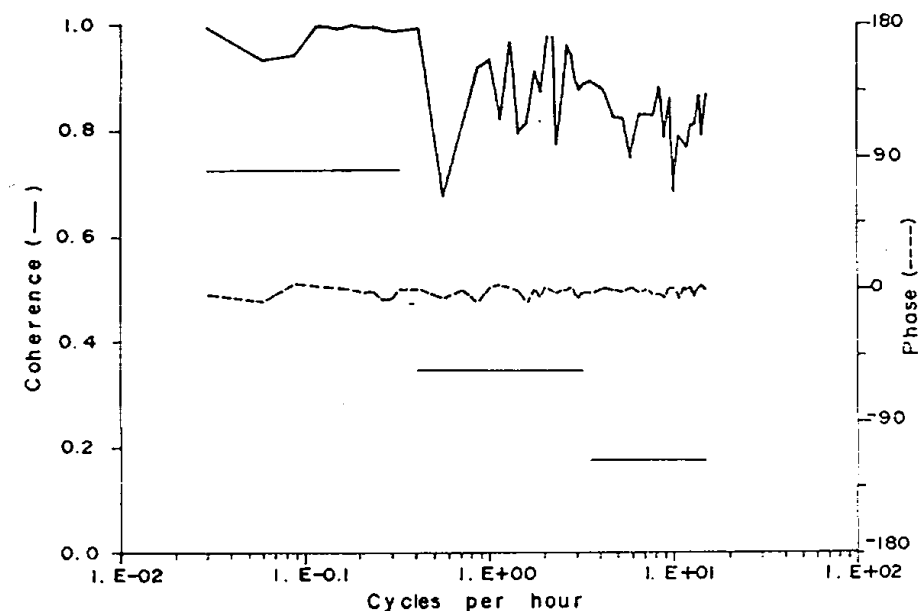

Fig. 6b. Phase & coherence spectra of v component of wind velocity.
Horizontal lines show 0.05 significance levels.

The Gill propeller sensor is reported to be accurate to within 1% (KONDO *et al*, 1971) and recently Large (1988) had demonstrated their potential for real time computation of momentum flux over oceans using inertial dissipation methods. The only drawback observed with the propeller sensor was their tendency to pick up spurious signals through the inductive coil used in the sensor. An installation near a VHF power antenna showed high values of propeller counts whenever the VHF set was operated. The use of propeller with inductive sensing should be carefully checked for such effects on shipboard use where high frequency transmissions are common.

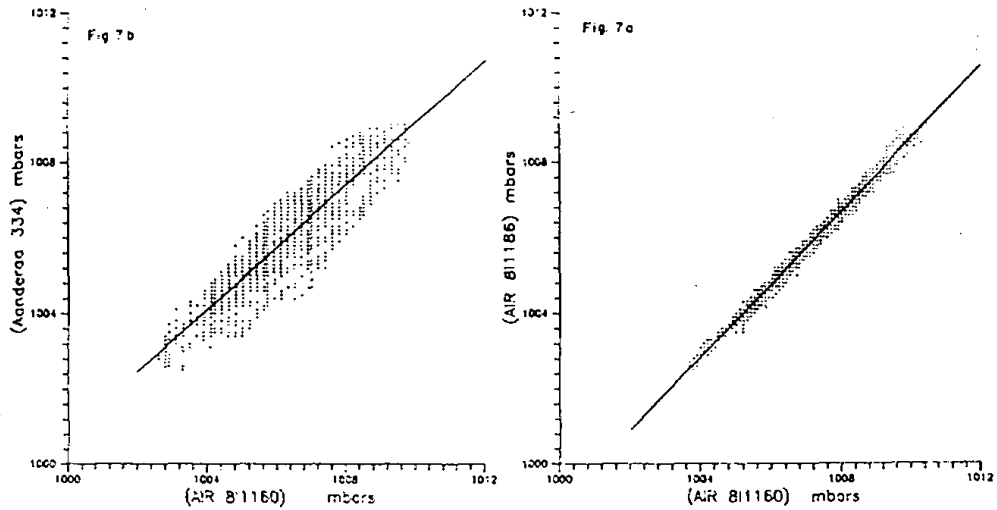

Fig. 7a. Scatter plot of AIR pressure sensor outputs recorded over a period of 10 days.

Fig. 7b. Scatter plot of Aanderaa and AIR pressure sensor outputs recorded over a period of 10 days.

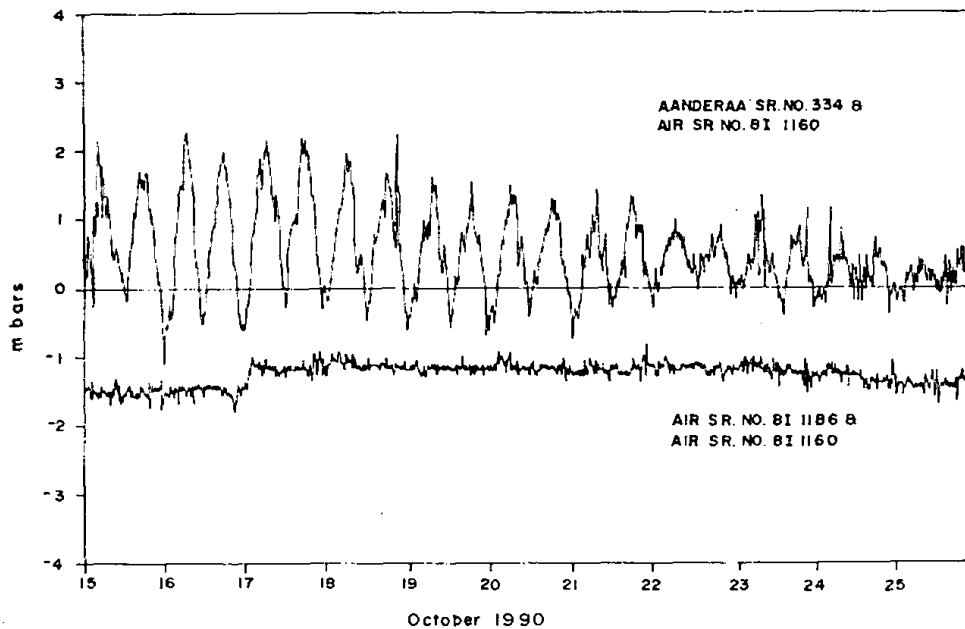

Fig. 8. Plot of pressure difference between sensor outputs.

Atmospheric pressure

The performances of two types of pressure sensors have been monitored. One is from Aanderaa Instruments and the other from Atmospheric Instrumentation Research (AIR). Aanderaa sensors use a small (4 mm by 4mm) silicon chip with diffused resistors that form part of a Wheat-Stone bridge whose output signal is proportional to the atmospheric pressure. The chip also has diffused heating resistors and a temperature sensing resistor allowing the sensor to be maintained at constant temperature during measurement.

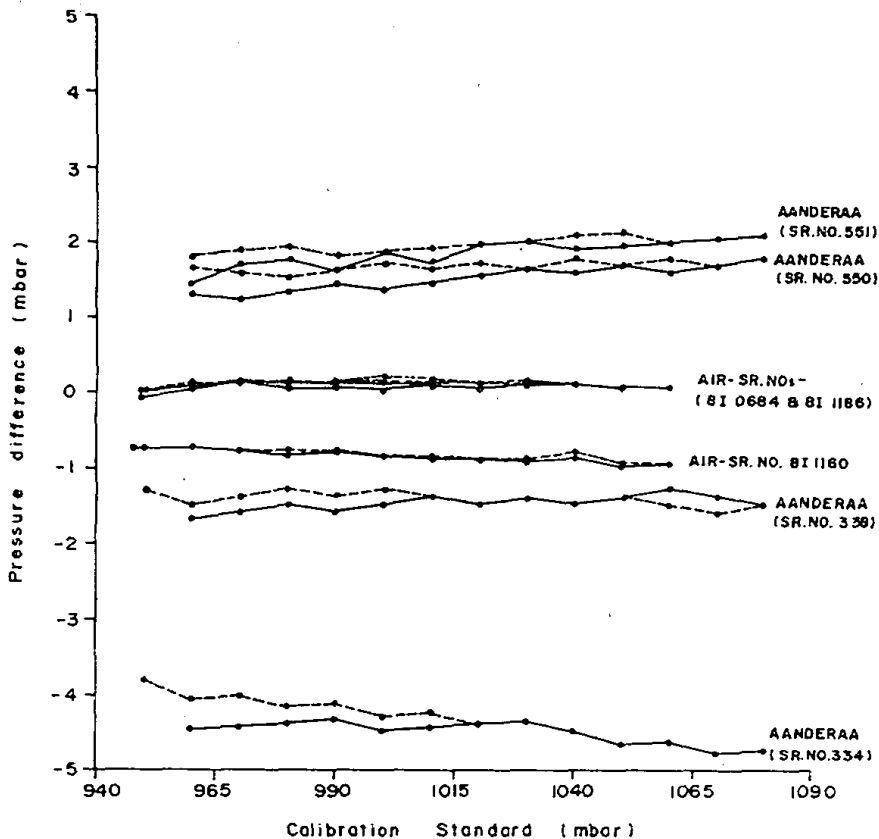

Fig. 9. Pressure sensor output deviations from laboratory pressure calibration standard.

AIR pressure sensor uses a capacitive sensing element and an integrated thermistor for temperature compensation. A built-in microprocessor takes care of calibration, temperature effects and computes pressure in engineering units. The data is available in both serial and parallel formats.

The data from two AIR pressure sensors and one Aanderaa sensor were logged for a period of 10 days. Figure 8 shows the time series of pressure difference from sensor outputs. Figures 7a and 7b shows the scatter plot of data. It is seen that the outputs of AIR pressure sensor (Sr. nos. 8I1186 & 8I1160) differed by a fixed offset of about 1.5mbar and the variations from their best fit were within ± 0.25 mbar. The differences between Aanderaa (Sr. No.334) and AIR (Sr. No.8I160) sensor were higher than 3mbar as seen in figure 7b. Figure 9 shows the result of laboratory calibration of different pressure sensors. It is observed that AIR pressure sensor are more reliable. They also provide digital outputs in engineering units and in addition are low powered and therefore well suited for remote stations. Their long term stated accuracy is of the order of 1 mbar/year. Aanderaa sensors on the other hand show variations from manufacturer's calibration and lower accuracy and repeatability. The calibration of pressure sensor prior to deployment and also after retrieval is essential for improved confidence in the data set.

Air temperature

Aanderaa air temperature sensor uses a 500 ohm film type platinum resistor as sensing element. The sensor probe is covered by radiation shield to protect from solar heating. The laboratory calibrations showed that sensor outputs were accurate within

$\pm 0.2^{\circ}\text{C}$. This accuracy was good enough in view of uncertainty of ($1 - 3^{\circ}\text{C}$) due to heating of the shield caused by the sun at low winds.

Relative humidity

Two types of sensors were procured viz Vaisala Humicap Sensor and Aanderaa relative humidity sensors. Vaisala Humicap sensor uses a capacitive sensing element which produces an output voltage which is linear function of relative humidity. The Aanderaa sensor uses hygroscopic hair with diffused resistor as sensing element. The resistance of the sensor is related to humidity through a third degree polynomial equation. The laboratory calibration of two sensors of each type were attempted, and in some the offset were beyond the sensor range and in the others stability and repeatability was not found. The humidity sensors were not used on any field installation. PAYNE (1988) report the use of Humicap sensors on their meteorological recorder (MR) package developed for use on buoys. The Humicap sensor on MR were shielded with a membrane to avoid salt deposition which can cause shifts in calibration and also sensor failure. In spite of shielding, only two sensors out of 14 deployed provided reliable data. There is a lack of a reliable humidity sensor for long term unattended measurements, and we intend to include a psychometric sensor for land use where routine maintenance will be possible.

CONCLUSION

The design aspects of a simple, modular and flexible data acquisition system for meteorological measurements is presented. The system allowed programmability of sampling and averaging intervals and performed computation of sensor equations and vector averaging of winds. This facility permitted more intense sampling of the Aanderaa wind sensors eliminating effects of aliasing errors in the energy density spectra producing better results than previously reported for Aanderaa Wind Recorders.

The system facilitates an easy retrieval and inspection of data via RS-232 link. Modularity allowed different sensors and storage options. Use of EPROM storage media has been reliable. However in view of the possibility of contact problems in replacement of EPROMs, the option of battery backed CMOS RAM and use of portable PCs for data retrieval was preferred in later models. Recently introduced FLASH EPROMs have all the advantages of EPROMs besides being electrically erasable in circuit.

The Aanderaa suite of sensors have been largely used with this system. The performances of wind speed, wind direction and temperature sensor have been satisfactory. The atmospheric pressure sensor however showed consistently lower accuracy and reliability than specified. The Gill propeller vane anemometer and AIR pressure sensor were observed to be more accurate and easy to use. Laboratory tests with Vaisala and Aanderaa humidity sensors prohibited their use in field installations.

The system has been used in different configuration for different applications such as atmospheric dispersion studies, wind energy studies and coastal oceanographic studies.

Acknowledgments - The authors wish to thank Dr. B N DESAI, Director, National Institute of Oceanography, Goa, for extending the use of laboratory facilities. The mechanical design, fabrication and field installations were done by V N CHODANKAR. HEMANT KAMAT was responsible for initial hardware testing and programming. The authors also wish to thank G NARAYANASWAMY for his interest and colleagues from instrumentation division E S DESA, M R NAYAK and A JOSEPH for encouragement and suggestions. They gratefully acknowledge the help of A FERNANDES in data analysis and of ASHOK KUMAR for sensor calibration.

REFERENCES

- DESA E., A.P. SELVAM, R.G. PRABHU DESAI, M.R. NAYAK AND S. TENGALI (1983) An Automatic Recording Weather Station. *Scientific Report of First Indian Expedition to Antarctica*, 18-29.
- FREITAG H.P., M.J. McPHADEN and SHEPHERD (1989) Comparison of Equatorial Winds as Measured by Cup and Propeller Anemometers. *Journal of Atmospheric and Oceanic Technology*, 327-332.
- KONDO J., N. GEN-ICHI and Y. FUJINAWA (1971) Response of cup anemometer in turbulence. *Journal of Meteorological Society of Japan*. 49, 64-74
- LARGE W.G. and J.A. BUSINGER (1988) A system for Remote Measurements of the Wind Stress over the Oceans. *Journal of Atmospheric and Oceanic Technology*. 5, 274-285.
- PAYNE R.E. (1988) The MR, a Meteorological Data Sensing Recording and Telemetering Package for Use on Moored Buoys. *Journal of Atmospheric and Oceanic Technology*, 5, 286-297.
- PRABHU DESAI R.G. AND B.A.E. DESA (1986) A ship-Borne Meteorological Station for Ground Truth Measurements. *Proceedings MDS-86 International Data Symposium*.290-295.
- SELVAM A.P. (1986) Data Buoy. NIO Technical Report NIO/TR-3/86.
- WELLER R.A, R.E. PAYNE, W.G. LARGE and W. ZENK. (1983) Wind Measurements from an Array of Oceanographic Moorings and from F/S Meter during JASIN 1978. *Journal of Geophysical Research*, 88 (C-14), 9689 - 9705.