

# COLLECTED PAPERS

THE INTERNATIONAL SYMPOSIUM ON THE USES OF  
COASTAL OCEAN SPACE

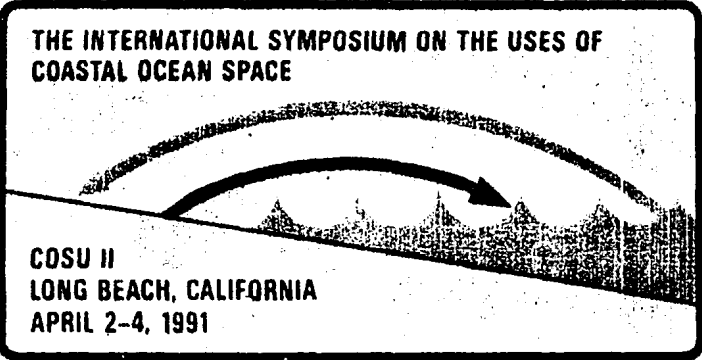

COSU II  
LONG BEACH, CALIFORNIA  
APRIL 2-4, 1991

## THE SECOND INTERNATIONAL SYMPOSIUM ON COASTAL OCEAN SPACE UTILIZATION (COSU II)

APRIL 2-4, 1991

SHERATON LONG BEACH AT SHORELINE SQUARE  
LONG BEACH, CALIFORNIA

**DEVELOPMENT OF COASTAL WASTE LANDS THROUGH OCEAN COUPLED SOLAR PONDS FOR PRODUCTION OF POWER, FRESH WATER AND MARINE CHEMICALS AND FOR RAISING AQUACULTURE FARMS FOR THE GROWTH OF RURAL ECONOMY IN THE DEVELOPING COUNTRIES.**

**J.S.Sastry, C.K.Gopinathan and Gajanan.P.Naik.  
National Institute of Oceanography,  
Donapaula, Goa-403 004,India.**

**Abstract.** Ocean coupled solar pond power plants utilize warm water (85°C) through salt gradient, conventional solar pond and cold water (15°C) drawn from the edge of continental shelf (200-220 m) for power generation. Thus the temperature difference utilized is around 70°C. These power stations can be located in tropical coastal regions and have several distinct advantages over conventional OTEC/solar pond power plants. Cold water is rich in nutrients and is free from pathogens and hence ideal for aquaculture. The waste heat could be utilized for vacuum flash distillation for fresh water. The cold water can further be utilized for the production of salt and marine chemicals. In an open cycle flash method of power generation, water is automatically produced as the by-product.

The paper discusses the technologies involved in the global scenario. These ocean coupled solar power plants could be set up in areas where insolation is high for long duration and where the width of the continental shelf is comparatively small. Several places along the tropical coastal belt, especially African coasts are ideal. Apart from the by-products these projects are labour intensive, generating employment to skilled and unskilled workers and is ideal for coastal communities in developing and underdeveloped countries where most of the coastal waste lands exist. The authors examine the various technologies already existing and socio-economic benefits of such projects.

## INTRODUCTION

The coastal ocean space may be considered as extending from the high water line to the wind induced sand carpeted region within which salt intrusion takes place with little or no fresh underground water. The area defined is primarily without any vegetation and is considered as coastal waste land for all practical purposes. On the seaward side the coastal ocean space may extend to the edge of the continental shelf. This area comprises the sand dunes and the intertidal regions. It is in this area where several major rivers enter the sea where deltas are formed. It is in this area the harbors are located. The major human activities are confined to this coastal ocean space. Interspersed amongst the various cities and the habitats are conglomerations of communities mostly living on the fisheries. Slightly remote from these areas one can find vegetation and irrigated crops provided there are fresh water resources.

Without going into the economic theories, we shall classify the various countries bordering oceans into three types. When the individual (family) income of the majority of families far exceeds the expenditure for daily necessities like housing, food, clothing, children's education, etc., the society may be termed affluent and the country is categorized as advanced. The per capita energy consumption is very high and their resources are extremely good. We categorize the developed countries as those countries in which the majority of the families would have just enough income to meet their needs. In the underdeveloped countries, the majority live well below the required levels of standard. In other words, their income is far below their necessities.

The coastal ocean space comprises beaches of different categories interspersed by rivers and rivulets, which offers a variety of entertainment programme for recreation and it is primarily the first category of the people who visit these places for boating, surfing and other water sports and entertainments. In the second category, even though the countries are well developed with fairly good industrial support and infrastructure the majority will not be able to utilize the coastal ocean space for recreation. In the third category, people do not have either the means or capabilities to utilize the coastal ocean space for entertainment. The coastal ocean spaces are nearly unused. In this paper, we present an outline of a programme for the socio-economic upliftment of thousands of semi-skilled and unskilled population who stay along the vast coastal wastelands. The project envisages the construction of an ocean coupled salt gradient solar pond power station. In this system, we pump cold sea water from 200 m depth for the condenser cooling and this water is proposed to be used as a resource for salt production and aquaculture.

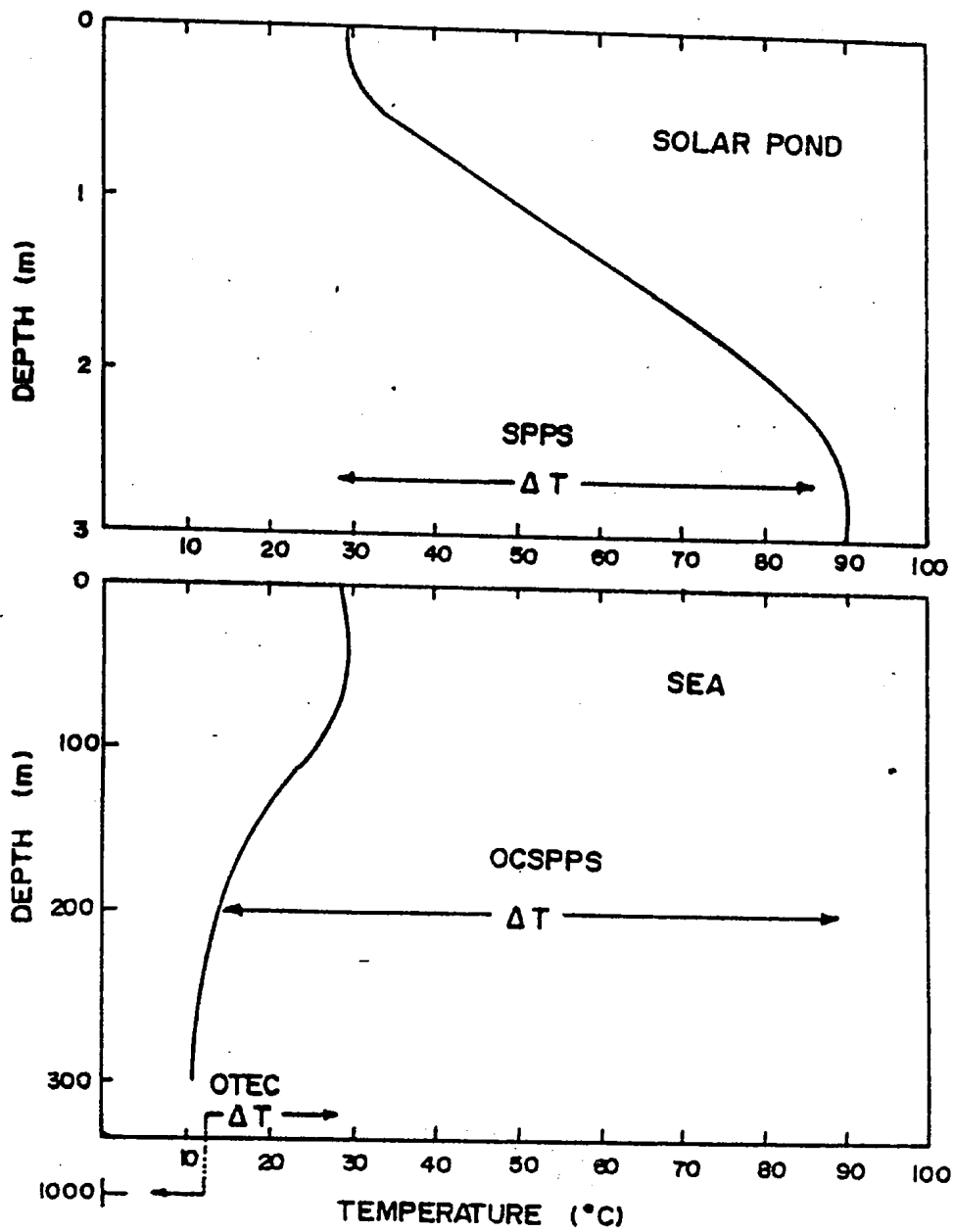

Figure. 1. Distribution of temperature in a solar pond and tropical ocean. Available  $\Delta T$  for solar pond, ocean coupled solar pond and OTEC power plants are also shown.

## OCEAN COUPLED SOLAR POND POWER STATION (OCSPPS)

The ocean coupled solar pond power station is a concept presented earlier [1]. In fact, it is a hybrid between a solar pond power station (SPPS) and ocean thermal energy conversion plant (OTEC).

The solar pond is an artificially constructed tank, 2 to 3 m deep, with black bottom of suitable material. The tank is filled in such a manner that there exists two convecting zones at the top and the bottom, separated by a nonconvecting zone. The incident solar radiation is absorbed at the bottom of the tank and the bottom water is heated. Because of the density (salinity) structure in the pond, the warm water is confined to the bottom convecting zone, even though temperatures may be as high as 90°C. An excellent review on non-convecting solar ponds is given by Tabor and Weinberger [2]. In SPPS, the warm water is used as a heat source and the surface sea water at a temperature of 25-30°C as a heat sink. On the other hand, the ocean thermal energy conversion plants utilize the surface sea water as the heat source and cold water from a depth of about 1000-1200 m as the heat sink. The temperature difference ( $\Delta T$ ) utilized for power generation is about 20°C, in contrast to about 55°C in the solar pond power station. The ocean coupled solar pond power station proposes to produce hot water at about 85°C through the construction of the solar pond built on coastal wastelands and use the cold water at about 15°C drawn from a depth of 200 m as a heat sink. Thus the temperature difference is about 70°C. Fig.1 shows the thermal structure and associated  $\Delta T$  in the solar pond, the ocean coupled solar pond power station and OTEC. OCSPPS has a number of advantages over the OTEC and the solar pond power plants. In OCSPPS the Carnot efficiency which depends upon the temperature difference  $\Delta T$  is about 16% whereas it is 3.4% and 12% respectively for the OTEC and SPPS. The corresponding Rankine cycle efficiency is higher in OCSPPS. In the OCSPPS, sea water is pumped from a depth of 200 m whereas the OTEC plant requires water from a depth of 1000 m or more. Because of the poor efficiency, large volumes of water are needed for energy transfer. Attendant problems like the release of CO<sub>2</sub> in OTEC plants are constraints. These plants will be located probably on offshore platforms and transfer of energy to the user is a major problem. In contrast, the cold water drawn from a depth of 200 m for OCSPPS will have nearly the same concentration of CO<sub>2</sub> as the surface water. This water being rich in nutrients, can be used as a resource for the development of aquaculture. Some of these aspects are presented in the later sections. In the following, we shall discuss areas best suited for OCSPPS in the global context and the technologies which may become a part of the total facility. The energy budget for a 1MW plant is presented for a community of 2000 families with rural background. In Appendix I, we provide a detailed computation.

## AREAS SUITABLE FOR OCSPPS

The prime considerations for locating the OCSPPS are

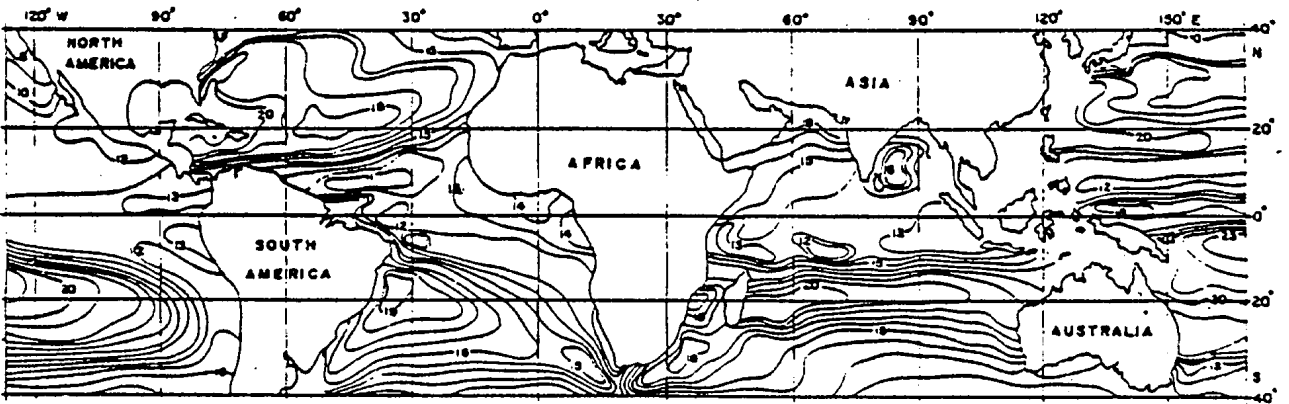
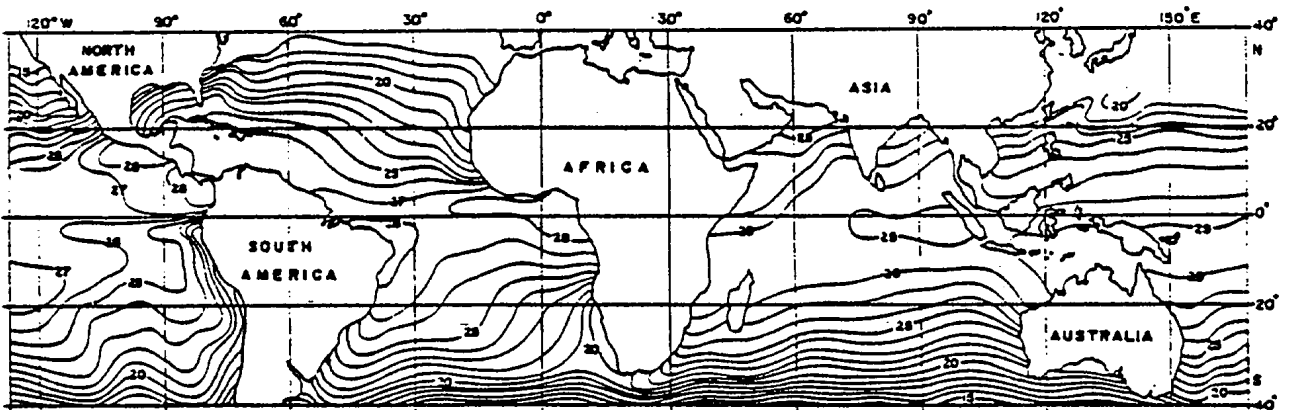
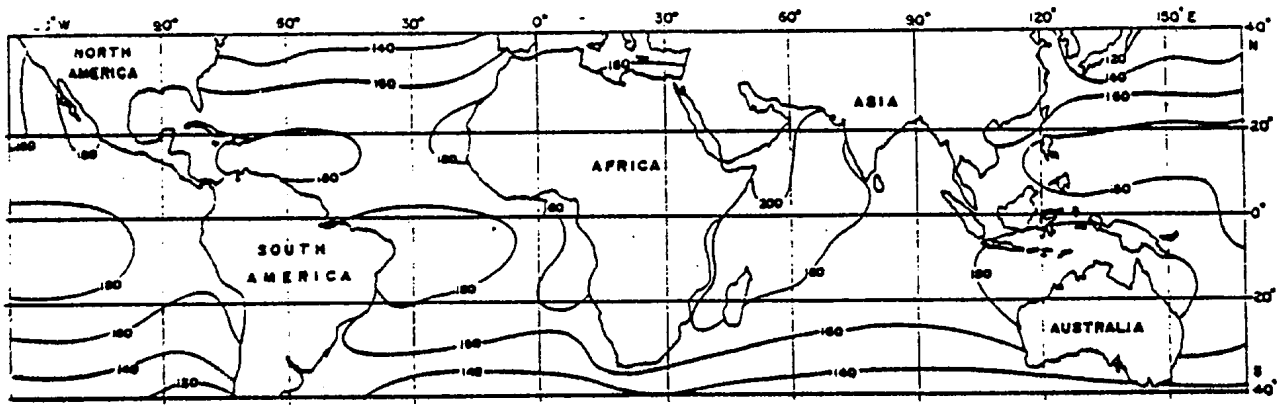

Figure. 2(a). Annual mean distribution of global solar radiation at the ocean surface. (b). Distribution of temperature at the sea surface of the world oceans. (c). Distribution of temperature at a depth of 200 m in the world oceans.

- 1) High insolation.
- 2) Cloud free regions.
- 3) A narrow continental shelf.
- 4) Availability of coastal ocean spaces and wastelands in low lying areas.
- 5) Local climatic conditions.

The incident solar energy is a function of the latitude. There is a sharp drop of the incident solar radiation beyond the tropics and intuitively the ideal locations for the development of solar plant power stations are the tropics. Fig. 2(a) shows the annual mean incident solar radiation at the surface of the oceans over the region between 40°S and 40°N, the annual mean radiation varies between 200 and 120 kcal/cm<sup>2</sup>. In the tropical oceans, the annual mean radiation exceeds 180kcal/cm<sup>2</sup> [3]. Fig. 2(b) and 2(c) show the distribution of temperature at surface and at 200 m [3] in the tropical oceans respectively. One can see clearly that over most of the regions, the temperature at 200 m varies considerably, centered around 15°C and this may vary marginally from season to season. Thus, the tropical regions are also ideal from the point of view of the availability of cold water. Fig. 3 shows the bathymetry (1000 m isobath) adjoining the landmass bordering the Indian Ocean. The continental shelf is very narrow along the African coast, Saudi Arabia, Pakistan and to some extent along certain portions of India and western Australia. Madagascar and the other islands have cold sea water available within a few kilometer from the shore. A close examination of the bathymetric charts in the tropical region suggest that the ocean coupled solar pond power stations could be located along the east coast of Africa, Arabia and in some regions of southern India adjoining the east coast and at several other locations provided there are enough coastal wastelands. Most of the countries which lie in the tropics are under-developed with meagre freshwater resources. The data presented earlier on insolation, temperature variations at surface and 200 m and the width of the continental shelf [4] indicate the regions which would have maximum socio economic impact by OCSPPS (Fig.4), though additional data are needed. In the Indian context, over Tamil Nadu and Andhra Pradesh bordering the east coast of India, the incident solar radiation level is fairly high 5-6 kW-h/m<sup>2</sup>. The width of the continental shelf varies between 10-25 km. Several thousand hectares of wasteland is available between the major cities and finally the populations living in these belts may be categorized as under-developed, needing socio-economic development.

A detailed analysis of the climatic features of the area is essential. Cyclones could be a major threat for the solar pond. The soil and subsoil characteristics, ground water table and its variations determine the design features of the solar pond. Seasonal weather characteristics need to be investigated for optimization of extraction of power and for maintenance works.

Since the quantum of power generation depends upon the daily input of the solar radiation, monitoring of the atmospheric conditions is essential. Evaporation processes also play an important role on the

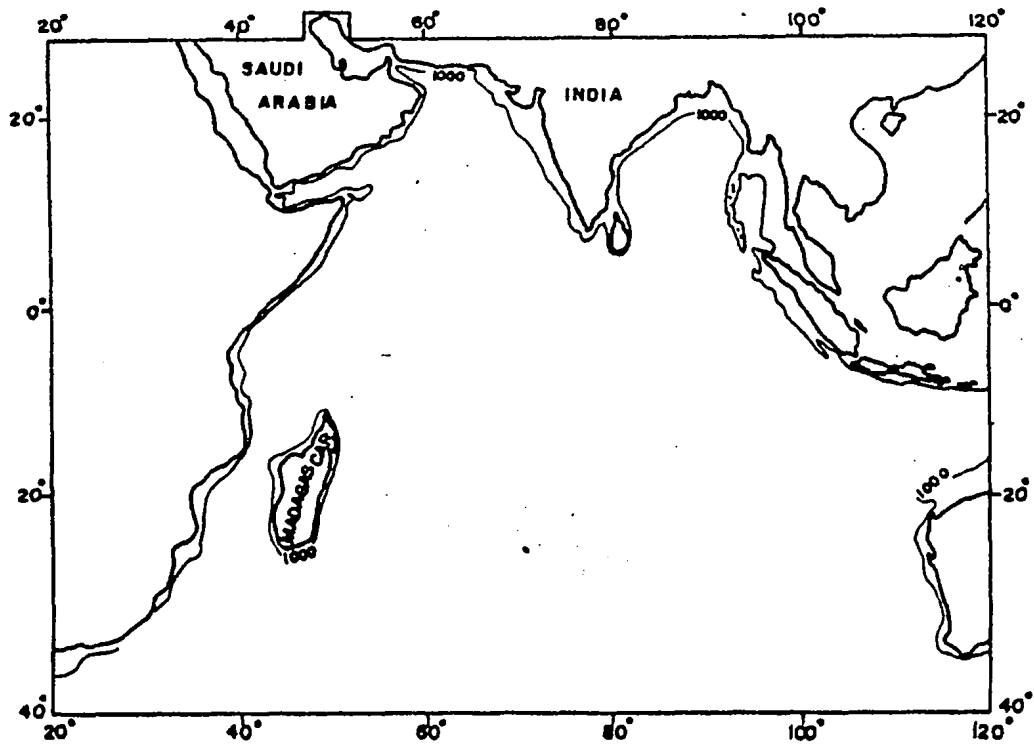

Figure. 3. The width of the continental margin in the Indian Ocean.

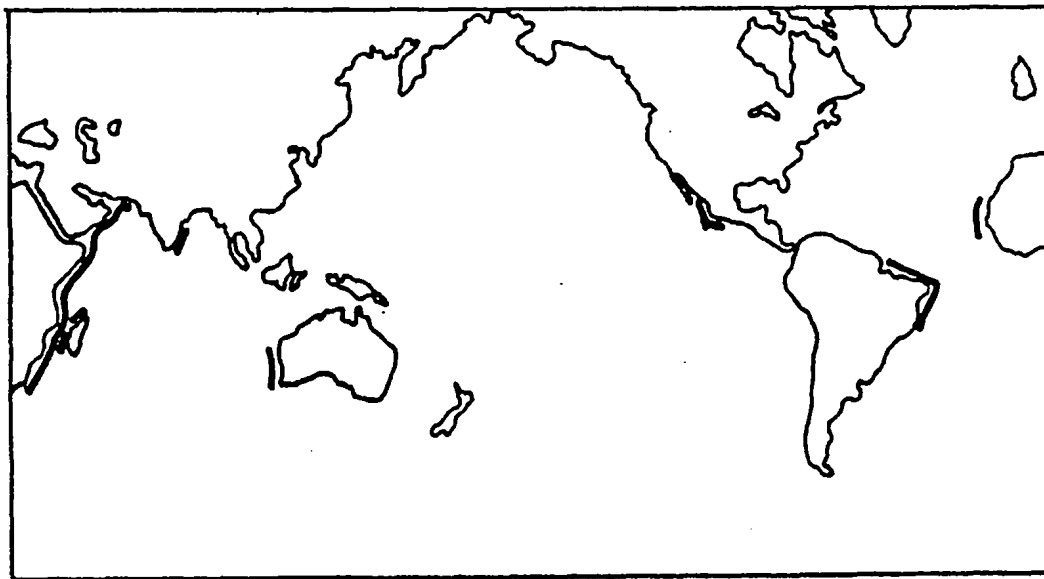

Figure. 4. The coastal area of the world where conditions are favorable for establishing OCSPPS.



salinity structure of the pond and replenishment of water must be on a routine basis. Proper precautions need to be taken for the maintenance of the pond.

### POWER PLANT

The Solar pond supplies the hot brine at about  $85^{\circ}\text{C}$  as the source of heat and the cold sea water of about  $15^{\circ}\text{C}$  obtained from about 200 m depth serves as the heat sink. The working of the thermal energy conversion is shown in Fig. 5. The power pack consists of an evaporator, condenser, turbine, generator and the Freon pump. These components are to be designed on a detailed analysis. Initially, Freon-11 has been chosen as a working fluid for its high efficiency in closed loop cycle. Its thermodynamic properties are suitable to work between temperatures  $15\text{-}85^{\circ}\text{C}$  [5]. The suitability of other working medium are also under investigation.

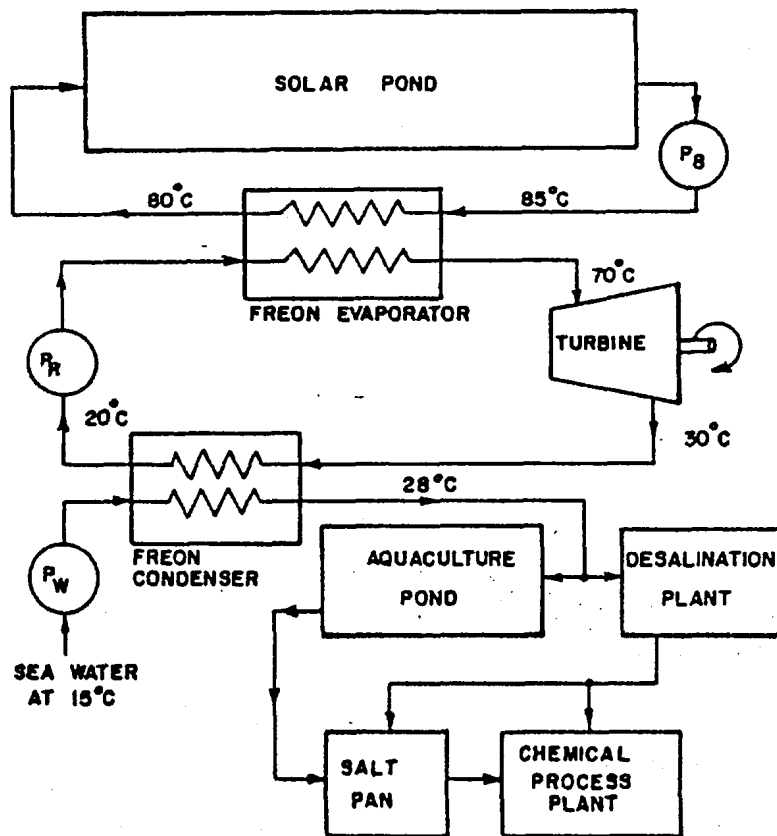

Figure. 5. Schematic for presentation of the working of the power plant of the OCSPPS.

Freon-11 extracts heat from the hot brine pumped from Solar pond through the evaporator. The superheated Freon vapors enter the turbine at about  $70^{\circ}\text{C}$  and expand isentropically driving the turbine, generating power. The vapors leaving the turbine at about

30°C are further condensed in the Freon condenser to about 20°C by the incoming sea water at 15°C pumped from about 200 m depth. The cooling water temperature will be raised to around 28°C, absorbing latent heat of condensation of Freon vapors. The Freon condensate is pumped back to the evaporator and the cycle is repeated for generation of power. For 1 MW power plant the liquid Freon-11 pumping requirement is estimated to be approximately 0.05 m<sup>3</sup>/sec (see Appendix I).

### PIPE LINE LAYOUT

For pumping cold water from a depth of 200 m we propose laying a

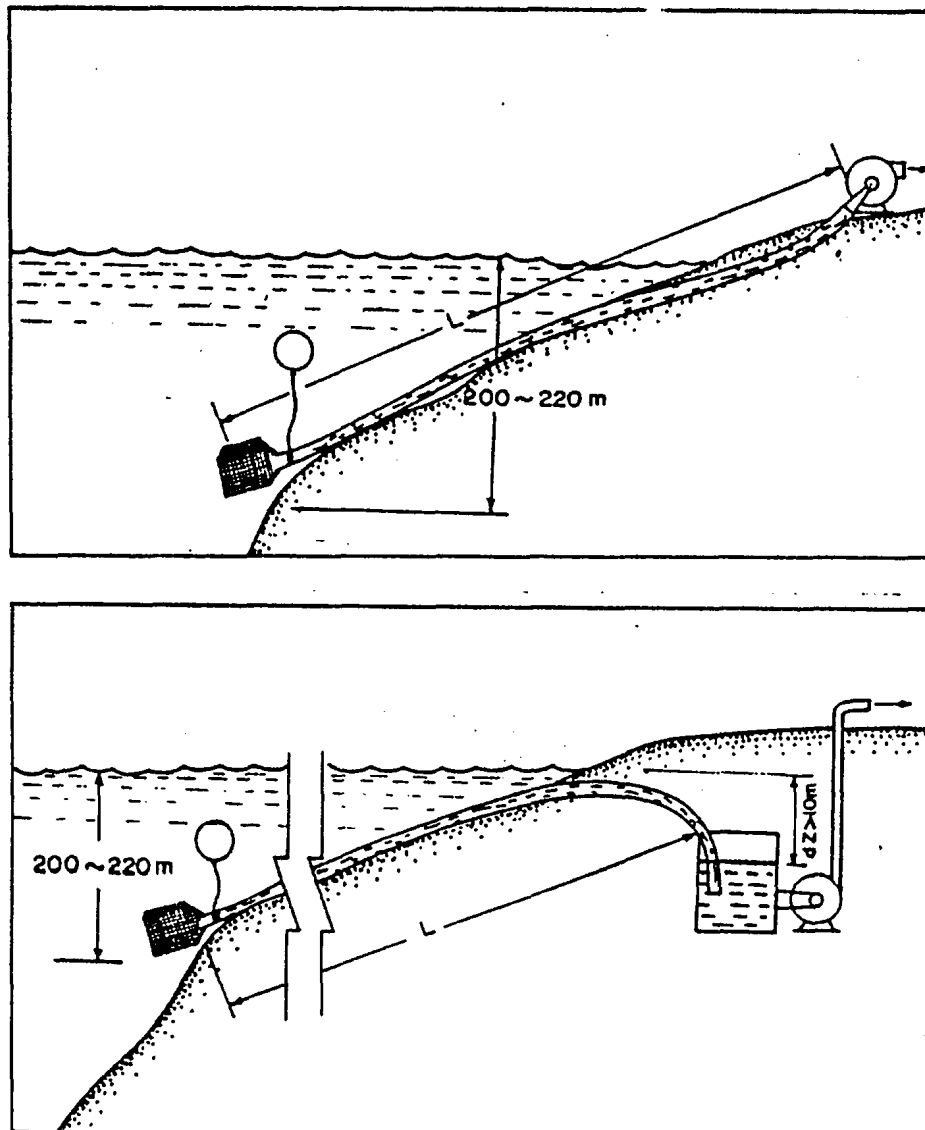

Figure. 6. Schematic for presentation of the types of coolant water pumping to be employed. (a) Direct pumping (b) Syphoning and pumping.

pipe extending from the edge of the continental shelf to the shore where it is buried underground so that the wave breaking near the coast has no effect on the pipe. The pipe line with a very low thermal conductivity is chosen. As the water is drawn from 200 m, we do not envisage serious bio-fouling within the tube. The energy required to pump sea water is a function of the diameter of the pipe, the friction factor, and the length of the pipeline and the required volume flux. We envisage two alternative techniques for

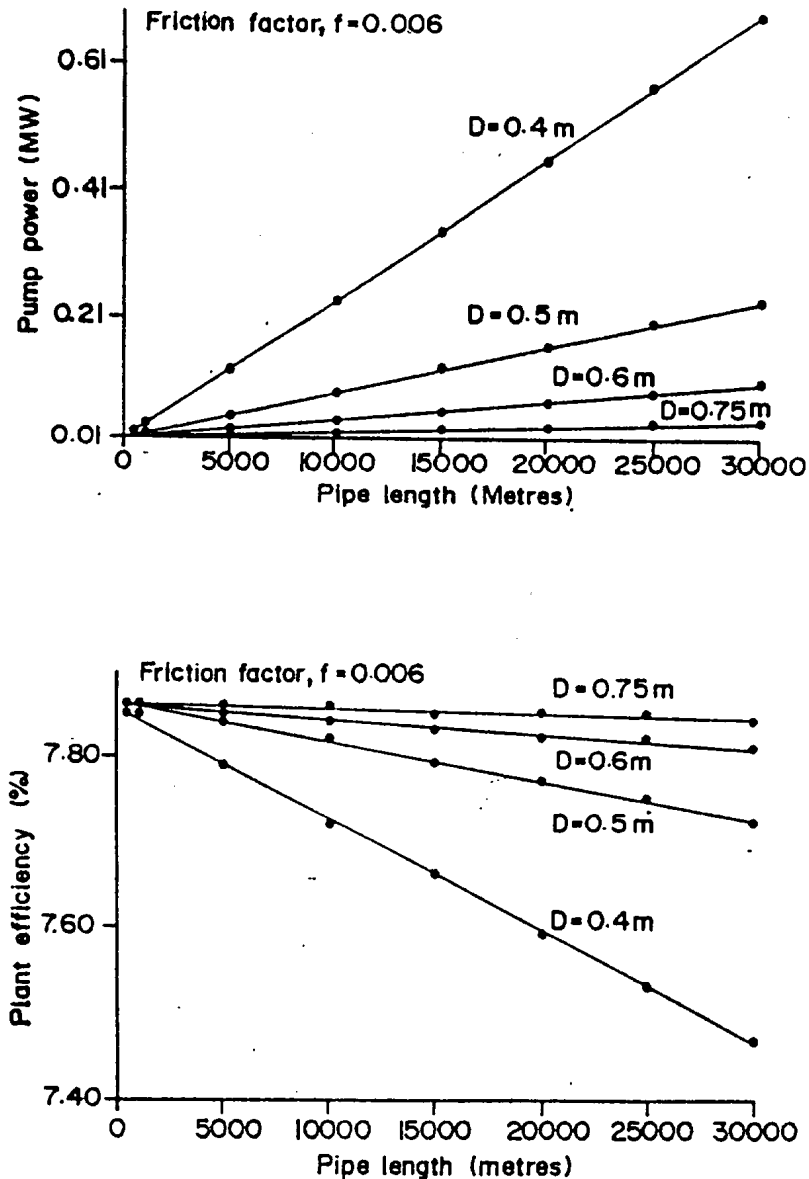

Figure.7(a). Variation of pumping power requirement with pipeline for different pipe diameters. (b). Variation of power plant efficiency with different diameters and pipeline.

pumping as shown in fig.6. Fig. 6(a) shows direct pumping where as Fig.6(b) shows an inverted manometric technique for siphoning from a depth of 200 m. The cooling water requirement for 1 MW power plant is estimated at 220 l/sec for the Freon closed cycle plant (Appendix I). The pumping power requirement and plant efficiency for pipes of different diameter and length are shown in Fig.7(a) and 7(b). The plant efficiency and pump power varies as a function of pipe length and diameter of the pipe. For example, a pipe with diameter of 0.6 m and 15 km long will need a pump power of 0.050 MW [6]. As such the power requirements for hot brine pump and Freon pump and for the cooling water pump are low compared to the heat supplied by hot brine. The Rankine cycle efficiency is around 9.45%. As the pipeline length increases or the diameter of pipe decreases, additional power is needed to pump the equal volume of cold water.

The power plant cost will be minimum for the regions where the cooler sea water is available close to the shore. In case of wider shelves higher suction head is encountered with narrow pipes where in there will be a need to install the submersible pumps. The task of installing submersible pumps at sea, laying the associated power cables and the maintenance are all cumbersome. The pump and the power cables are exposed to the vulnerable sea climate. This can be avoided by inverted manometer technique as shown in the Fig.6(b).

Sea water can be siphoned through a long pipe line to the shore based siphon tank. The required flow rate can be achieved by maintaining a desired static head ( $dZ$ ) between the sea level and the level in the siphon tank. Diameter of the siphon pipe, pump suction and delivery pipes may be suitably chosen for the required continuous discharge. The pump can be fitted outside the siphon tank as shown and the water may be pumped to the power plant. The pump installation and maintenance are very much simple.

## DESALINATION PLANT

As we have mentioned in introduction, the coastal ocean spaces have little or no fresh water because of salt water intrusion into the land. In such cases a desalination plant would be extremely useful for supplying part of fresh water required by the local communities.

A multistage flash (MSF) desalination plant may be coupled to OCSPPS. This dual purpose plant will generate the fresh water in addition to the electrical power. There is an abundant quantity of sea water readily available at the discharge of the power plant condenser. A part of this water can be utilized as the feed water for the generation of fresh water in the desalination plant.

Fig. 8 shows the schematic working of a two stage desalination plant. The boiling point of the sea water can be lowered by decreasing the pressure. The feed water boiling may be effected at the temperature of 50-65°C in the pressure range of 0.12-0.25 kg/cm<sup>2</sup> absolute [5]. Part of the sea water discharge from the power

plant condenser is directly fed to the water vapor condenser of the desalination plant. The feed water gets preheated and its temperature is raised to about  $38^{\circ}\text{C}$  by extracting the latent heat of condensation of the water vapor. The preheated feed water enters the evaporator stage-I (HTR I) and is heated by the part of the power generated at the power station. About  $0.25 \text{ kg/cm}^2$  absolute pressure is maintained in the HTR I. The feed water evaporates at about  $65^{\circ}\text{C}$ . Part of this vapor is utilized in heating the feed water in the evaporator stage-II (HTR II). Here the pressure of about  $0.12 \text{ kg/cm}^2$  absolute is maintained where in the feed water evaporates at about  $50^{\circ}\text{C}$ . The vapor steam gets condensed here. This distilled water is sent to the flash tank where the vapor gets separated. This vapor further gets condensed in the vapor condenser. The vapor steam from HTR II mixes with the vapor from HTR I and enters the vapor condenser at about  $60^{\circ}\text{C}$ . The feed water passing through the condenser cools the incoming vapors and fresh water is generated in the distillate tank. The fresh water is drawn through the distillate pump. The vacuum is created by a mechanically operated air ejector (EJTR) which constantly drives out the air and the noncondensable gases.

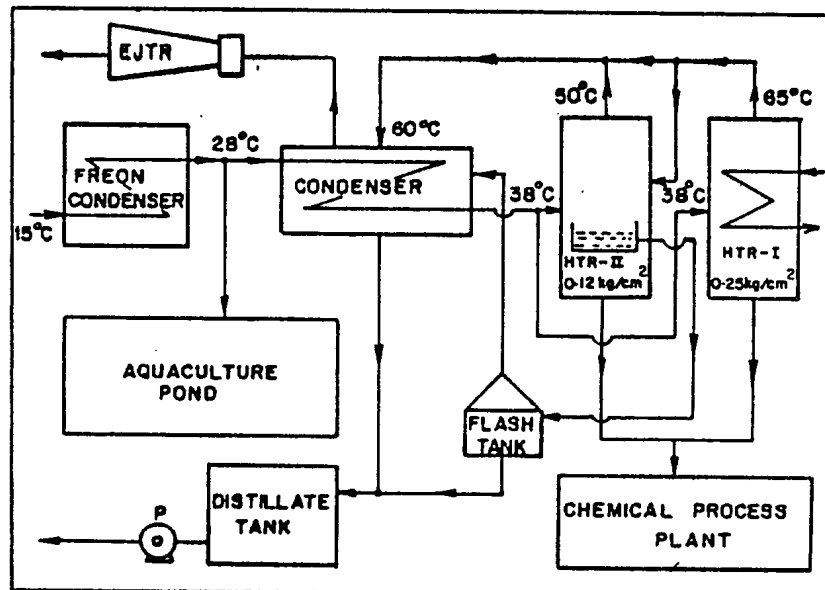

Figure. 8. Schematic representation of a two stage flash desalination plant.

- c) Salt ponds are ideal sites since they have well developed large condenser or evaporation ponds.
- d) Salinity requirement in the ponds prior to the introduction of Artemia is about 100 ppt. This should be maintained for a period of two months by regular intake of sea water.
- e) The temperature should not exceed 35°C; Ideal temperature is around 28-32°C.
- f) Minimum water depth 70-100 cm.
- g) pH should be around 8.
- h) The minimum size of the ponds could be 1 hectare and the maximum could be even upto 50 hectares.

During 1989-90, scientists from the National Institute of Oceanography have successfully demonstrated the artificial culture of Artemia in a solar salt farm of Gujarat (northwest coast of India). Artemia introduced in a 20 hectare condenser pan yielded approximately 400 kg of dry cysts of Artemia which is now being sold to shrimp hatcheries. There are immediate plans to increase the production by introducing Artemia into larger areas (500 ha).

Solar salt works are suitable biotopes for the integrated exploitation of salt, Artemia and eventually fish or shrimp. In salt works, Artemia is only found in the evaporation ponds at intermediate salinity levels from about 100 ppt onwards upto 250 ppt. If Artemia is not found naturally in the salt ponds, they could be easily introduced and cultured.

It may be noted that Artemia feeds by filtering microscopic food particles. In doing so, it swallows algae, particulate calcium carbonate and calcium sulfate impurities from salt water. This process improves the quality of the salt produced.

The annual cyst requirement of various shrimp hatcheries in India is about 2 to 2.5 T. With the commissioning of few more hatcheries in the next couple of years the requirement is likely to go upto 5T.

The annual world production of Artemia is around 200 T; Most of the production is from San Francisco Bay, Great Salt Lake and recently from People's Republic of China. Out of these nearly 100 T is consumed by Japan alone.

In OCSPPS, fertilizing the pond with organic or inorganic fertilizers is not required as the water which is pumped from below 200 m is normally rich in nutrients and hence will trigger the growth of microscopic algae which form the food of Artemia.

Shrimp Culture. Of the 1.7 million hectares of land suitable for aquaculture, only 30,000 hectares are presently used for shrimp culture. A traditional system of shrimp farming is in vogue in the states of West Bengal and Kerala for a long time. It essentially involves trapping of juveniles in the fields adjoining the backwaters and estuaries with the incoming tides and allowing them to grow until harvesting. However, this has many drawbacks and the returns are low (400-600 kg/ha) when compared to

Assuming about 80-90 kcal of heat will be required for generation of 1 kg of fresh water (7), the equivalent power requirement for generation of 60 T/day fresh water (expected need for about 300-400 families) would be about 0.275 MW. This power can be drawn from the power generated at the power station. No additional power will be required for pumping the feed water as it is directly fed from the power plant condenser. A marginal power of about 5 kW can be made available for driving the vacuum pump and about 2 kW for the distillate pump.

Assuming the fresh water conversion factor of 0.3, the quantity of feed water for the generation of 60 T/day fresh water would be about 200 T/day. The balance of the sea water will be available for aquaculture and salt production. A small quantity will be required as make-up feed water to compensate for losses due to evaporation and spill over. On generation of fresh water, the remaining portion of the feed water in the evaporators is rich in brine and chemicals and can be utilized for extraction of marine chemicals. If more fresh water generation is required, this can be achieved by additional installation of solar ponds or alternative heating .

## AQUACULTURE

In the OCSPPS, for consideration of increasing the efficiency we are pumping cold sea water from a depth of 200-250 m. The 200 m depth of water is available at the edge of the continental shelf. This water is rich in nutrients compared to that at sea surface. The water is free from pathogens being located offshore and at considerable depth. Suspended matter is minimal in this water. But for poor dissolved oxygen concentration, this water forms an ideal medium for aquaculture. Present day practices of aquaculture utilize sea surface water. The water needs suitable filtering for use in aquaculture ponds. In recent years, the aquaculture technology has been well developed in different parts of the world. Excellent overviews of the aquaculture practices in Asian countries can be found in [8,9].

Two Indian Examples. Along the Indian coast, vast areas suitable for aquaculture estimated at about 1.7 million hectares are available for aquaculture farms. Traditional system of shrimp farming is involved in certain regions. More recently, the culture of brine shrimp artemia in coastal salt works has been taken in a real earnest. Herein we give a brief summary of the requirements for the culture of the above in India.

1. Brine Shrimp Artemia in coastal salt works. The recent developments in aquaculture production of fish and shrimps have resulted in increased demands for Artemia cysts and adult biomass as valuable source of live food.

Prerequisites for successful culturing of Artemia.

- a) Tropical/sub-tropical climate.
- b) Closer to sea water source.

scientifically managed shrimp culture system in which productivity is of the order of 2-6 T/ha. Lack of species selection, predation, slow growth rates are the main reasons for this low return. Of about 55 species of shrimps occurring in the commercial landings in India, at least 15 are considered suitable for shrimp culture [10]. Of these Penaecus monodon, P. indicus & P. merquiensis assume priority because of the larger size attained, better survival in ponds and faster growth rates.

Seed of cultivable species of shrimps particularly that of P. monodon and P. indicus are collected in large numbers from the estuarine areas of West Bengal and Kerala. During seasons there is a flourishing 'seed industry' in these states. In addition, realizing the importance of shrimp culture and also realizing the fact that non-availability of seed is a hindrance in the propagation of shrimp farming, a few hatcheries have been set up along east and west coasts of India both in public and private sectors.

The Indian coast is blessed with good sunshine, required water temperature (25-32°C) and salinity (28-35 ppt) and other physico-chemical parameters ideal for shrimp culture. An ideal prawn farm in Indian conditions would cover an area of 1-5 hectares and would have a water depth of 1-2 m. Larger ponds would have channels dug from the main gate area towards the peripheral bunds. The technology for scientific farming and establishment of shrimp hatcheries is available in the country. When coupled with systems generating power using differentials in thermal structure shrimp culture would form an additional revenue source and also forms a source of employment for rural people. Systems using cooler subsurface water would bring up the nutrient rich waters and thereby create productive environment required for the farming.

The OCSPPS supplies cold water with a salinity of 35 ppt. After getting heated up in the condenser, the water is fed to the Aquaculture ponds with sufficient flow rate. This species which grow at about 35 ppt and around 30°C temperature will be grown initially. Later, this water is fed into the salt ponds. Because of evaporations and containment of water, the salinity and temperature in the salt pond increase where the brine shrimp *Artenia* could be cultivated.

#### MARINE CHEMICALS

Almost all naturally occurring elements are present in sea water. The present scale of production of chemicals from sea water is very large. Common salt, magnesium metal, and its compounds, gypsum and potassium compounds and bromine are presently recovered on an industrial scale [11]. The methods employed include adsorption, evaporation, distillation, solvent extraction, ion exchange, precipitation, electrolysis, flotation and oxidation. In general, production depends on more than one of the above methods.



## SALT PRODUCTION

The salt production is carried out by evaporation in three separate ponds. They are concentrating ponds, lime ponds and crystalizing ponds. The largest area is occupied by the concentrating ponds where most of the water is evaporated. Iron hydroxide and calcium carbonate precipitates in this pond and relative density of water increases from 1.027 to 1.16. It gets further concentration to a density of 1.21 gm/cc in the lime ponds and gypsum gets precipitated here. The water is then passed on to carefully constructed harvesting pond and further evaporated until its density increases to 1.26 and most of NaCl is precipitated. The residual liquor, termed bittern is further processed to produce other chemicals.

The sea water discharged from the OCSPPS and the desalination plant is about 19000 T/day. Assuming 9 months of operation in a year the total salt production will be about 120,000 T/yr at a recovery of 2.5%. The area required for the salt pans is estimated to be around 1,500 hectares.

Fairly sophisticated technologies are available [11] for extraction of Magnesium and Magnesium compounds, bromine and potassium compounds.

The sea water (0.13% Mg) is treated with a suspension of lime (CaO). The magnesium is then precipitated out as hydroxide. The precipitated magnesium hydroxide is separated by filtration and converted to magnesium chloride which after purification and drying is reduced electrolytically to magnesium. The recovery by this way is 85-90%.

The magnesium chloride produced initially will be utilized for constructing more solar ponds. It is known that the magnesium chloride gives better stability to the solar pond than sodium chloride.

Seawater is the world's principal source of bromine (66 gm/T). Using sulfuric acid, seawater is acidified to pH 3.5 and treated with a slight excess of chlorine. Bromine is then liberated according to the following reaction.

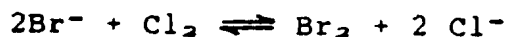

The liberated bromine is stripped off from the water with a current of air and then reacted with a gas phase with SO<sub>2</sub>. Hydrogen bromide is formed by the reaction as follows.

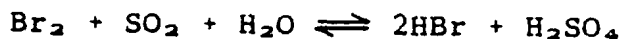

This hydrogen bromide is then absorbed in a relatively small volume of water. The resultant HBr is treated with Chlorine and Bromine is distilled off with steam. The output is  $2 \times 10^4$  T/yr.

## OPEN CYCLE POWER GENERATION

The open cycle utilizes a low pressure flash evaporation chamber to produce steam followed by expansion of the steam through the turbine and finally direct or indirect condensation by the coolant water. This type of plant works on the principle that the boiling point of water can be lowered by lowering the pressure on it as has already been mentioned. The warm water will boil in the flash evaporation chamber because of the partial vacuum. The steam generated thereby runs the turbine and generates power. If the spent steam is condensed by indirect contact with the cooling water, fresh water is a by-product of the power generation. The open cycle thermal energy conversion has a potential to produce upto 25% more power than in a closed cycle plant. The parasitic losses are considerably low in the of the open cycle power generation. One disadvantage of the open cycle operation is the requirement of a large size turbine for power generation.

## POWER UTILIZATION

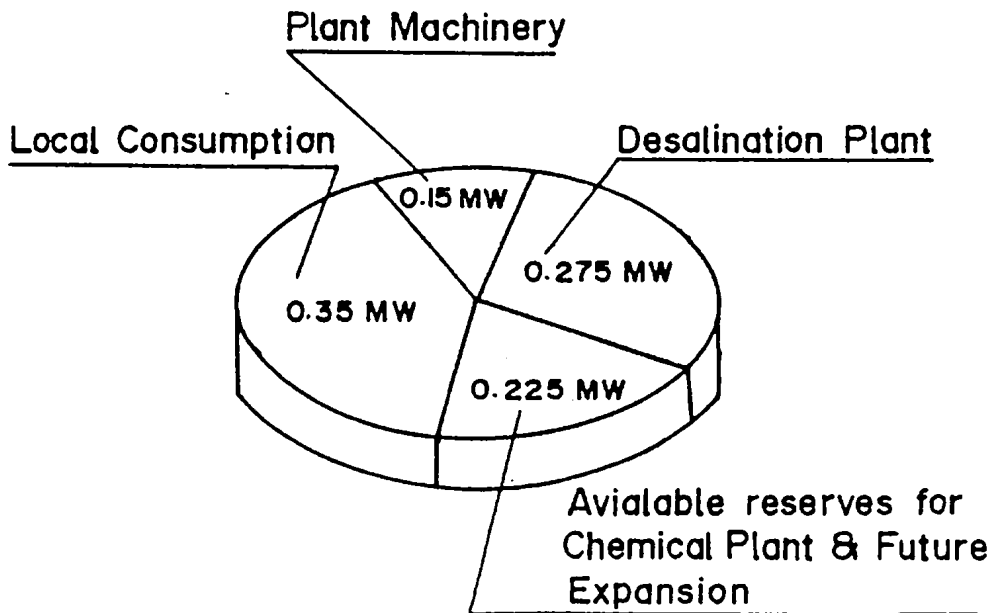

Figure. 9. Utilization of the energy budget of the project.

The power generated is proposed to be utilized towards,

1. Power plant lighting and running of the pumps and other machineries.
2. Local consumption for lighting and house hold appliances.

3. For the desalination plant.
4. As the reserves for chemical processing plant and for the future expansion.

A schematic representation of the proposed plan for the utilization of the power generated is given in the Fig. 9. Assuming an average consumption of about 40kW-h/month per consumer for lighting and household appliances, we may allocate about 0.35 MW [12] for this utility which will comprise of about 2000 families. About 0.15 MW will be needed for total plants' requirements. The balance, about 0.275 MW may be utilized for the desalination plant to supplement the fresh water and the surplus of 0.225 MW may be channeled for the chemical processing plant and as reserves.

### EMPLOYMENT POTENTIAL

The total project of power plant with desalination and chemical plants, salt and aquaculture farm is estimated to employ about 600 persons in various departments. This will result in an indirect employment potential to around 500-600 people in other areas like public offices, banks, schools, transport sector, hotels, shops, business institutions and small scale industries etc. Thus the project can develop a township with its own power and fresh water. The aquaculture products, minerals and chemicals bring in considerable revenue. A series of plants along the coast help in the generation of employment and will certainly give the socio-economic benefit to the country.

### CONCLUSIONS

1. All the coastal wastelands in tropical regions can be brought under the scheme.
2. A series of ocean coupled solar pond power stations would be developed to provide power for the local communities.
3. A number of salt and aquaculture ponds could be set up.
4. Chemical processing plants in the coastal waste lands could be established.
5. Skilled and unskilled labors could be employed in salt and aquaculture farms. In addition, several technical persons for running the plants and for developing new research and development techniques are employed.
6. As these plants are spread over the length of coastline, the socio-economic impact on the local population is expected to be very high.
7. As an accessory multistage flash desalination plants could be added to the plant for supplementing fresh water for the local population.
8. All the technologies outlined in this project are available. There is a need for scaling these technologies to suit the specific size at any given locality.

## ACKNOWLEDGEMENTS

The authors thank Dr. B.N. Desai, Director, National Institute of Oceanography for his constant encouragement. The authors have been benefited from the discussions with Dr. Joseph Royan and Dr. Sreekumaran Nair, during the preparation of the section on aquaculture in India. The authors thank Dr. P.S.N. Murthy for the cooperation extended.

## REFERENCES

1. C.K.Gopinathan and J.S.Sastry, 1983. Thermal Energy Conversion by coupling Solar Pond and Sea, Second Indian Conference in Ocean Engineering, pp. 1226-1239.
2. H.Tabor and Z. Weinberger, 1981. Non-convecting Solar Ponds, in Solar Energy Handbook, McGraw Hill Book Co, Chapter.10. pp. 1-29.
3. S.G. Govshkov, 1978. World Ocean Atlas-Volume 2 Pergamon Press Inc. New York, U.S.A. pp.306.
4. B.C.Heazen and M.Tharp, 1978. The Floor of the Oceans, Lamont Doberty Geological Observatory, Columbia University, New York. Chart 1.
5. G.A.Hawkins, 1966. Thermal Properties of Substances and Thermodynamics. In Marques' Standard book for Mechanical Engineers, Seventh Edition, Mc Graw Hill Book Co. pp.4.2-4.57.
6. J.F.Douglas, J.M.Gasiorek and J.A.Swaffield, 1985. Fluid Mechanics, Second Edition, Pitman Publishing Ltd, London. pp. 745.
7. A.B.Steinbruchel and R.D.Rhinesmith, 1980. A Design of Distilling Plants. In Principle of Desalination, Part A, Second Edition.Ed. K.S.Spiegler and A.D.K.Laird. Academic Press, Inc. pp.119-152.
8. H.R. Rabanal 1988. Development of Aquaculture Industry in Southeast Asia: An overview. In Perspectives in Aquaculture Development in South East Asia and Japan. Ed. J.V. Juario and L.V. Benitez, Aquaculture Department, Southeast Asian Fisheries Development Center, Philippines. pp. 3-38.
9. T.V.R. Pillay 1990. Asian Aquaculture: An overview, In Aquaculture in Asia (Ed) M. Mohan Joseph, Asian Fisheries Society, Indian Branch, Mangalore. pp. 31-42.
10. U.K. Gopalan and T.S.S. Rao, 1981. Shrimp farming. In Status Report on Coastal Aquaculture in India, NIO, Goa, pp. 61-92.

11. W.F. McIlhenny, 1975. Extraction of Economic Inorganic Materials from Sea Water, In Chemical Oceanography, Volume-4, Academic Press, New York. pp. 363.
12. C.D. Dimity, 1949. Rural Electrification Distribution Systems. In Electrical Engineers Hand Book Electrical Power, 4<sup>th</sup> Edition. Ed Pender and William, Wiley International. pp. 19.02-19.21.

## APPENDIX I

### DETAILS OF COMPUTATION

Solar Pond Area. Assuming an annual mean radiation energy of 5 kW-h/m<sup>2</sup>/day, an average value for Indian conditions, solar pond efficiency at 20% and power efficiency at 7.8%, the estimated area of the solar pond for generation of 1 MW power would be approximately 33 hectares.

Power Plant. For a 1 MW power generation, the quantity of heat supplied, rate of flow of the Freon, flow rate of hot brine and the cooling water and the pumping power requirements have been estimated. The Rankine efficiency and plant efficiency are also computed. The following assumptions have been made.

Turbine efficiency : 85%  
 Centrifugal pump efficiency : 85%  
 Friction factor for cooling water pipe : 0.006

1. Heat converted (Hc) into the mechanical work in the turbine is given by,

$$\begin{aligned}
 H_c &= \frac{\text{Power output (heat units)}}{\text{Turbine efficiency}} \\
 &= 1011800 \text{ kcal/hr} \text{ -----(1)}
 \end{aligned}$$

2. If Qr, the quantity of Freon required for the generation of 1 MW power, enters the turbine in the superheated condition at 70°C and leaves at 30°C,

$$Q_r = \frac{H_c}{H_{70} - H_{30}}$$

where, H<sub>70</sub> and H<sub>30</sub> are the heat contents of Freon vapor at 70°C and 30°C respectively.

$$\begin{aligned}
 \text{Then, } Q_r &= 220000 \text{ kg/hr.} \text{ -----(2)} \\
 \text{i.e. } &= 0.05 \text{ m}^3/\text{sec (approx)}
 \end{aligned}$$

3. Cooling water and the Freon exchange the heat in the Freon condenser. The cooling water temperature is raised from  $t_1=15^\circ\text{C}$  to  $t_2=28^\circ\text{C}$  with Freon getting cooled from  $30^\circ\text{C}$  to  $20^\circ\text{C}$ . From the heat balance, the cooling water flow rate ( $Q_w$ ) is given by,

$$Q_w = \frac{Q_r \times (H_{30} - h_{20})}{(t_2 - t_1) \times C_p}$$

where,  $h_{20}$  is the heat content of Freon liquid at  $20^\circ\text{C}$ .

Then  $Q_w = 763200 \text{ kg/hr.}$  -----(3)  
 i.e. =  $0.22 \text{ m}^3/\text{sec}$

4. Let  $Q_b$  be the flow rate of hot brine entering the evaporator at  $t_3=85^\circ\text{C}$  and leaving at  $t_4=80^\circ\text{C}$ . As a result Freon from  $20^\circ\text{C}$  vaporizes to  $70^\circ\text{C}$ .

$$Q_b = \frac{Q_r \times (H_{70} - h_{20})}{(t_3 - t_4) \times C_p}$$

i.e. =  $1988800 \text{ kg/hr}$  -----(4)  
 =  $0.56 \text{ m}^3/\text{sec}$

5. The Rankine efficiency ( $N_r$ ) is given by,

$$N_r = \frac{H_{70} - H_{30}}{H_{70} - h_{20}} = 9.45\%$$

6. Pumping power ( $P$ ) in kW is given by,

$$P = \frac{\rho \times g \times Q \times H}{N_p}$$

where,  $\rho$  is the density, ( $\text{kgm}/\text{m}^3$ )  
 $Q$  is flow rate in  $\text{m}^3/\text{sec}$   
 $H$  is the head in meter of water  
 $N_p$  is pump efficiency.

From this the power requirement for hot brine pump is,

$$P_b = 0.006 \text{ MW} \text{ -----(5)}$$

Power for the Freon pump is estimated at  $0.001 \text{ MW}$  (approx).--(6)

Now, the cooling water pump power ( $P_w$ ) varies with the pipe diameter and the pipe length. It is assumed that static head ( $H_s$ ) is  $2.0 \text{ m}$ , diameter of suction pipe ( $D_s$ ) is  $0.75 \text{ m}$ , diameter of delivery pipe ( $D_d$ ) is  $0.4 \text{ m}$ . The head ( $H_m$ ) generated by the pump is given by,

$$H_m = H_s + H_f + H_d \text{ where, } H_f \text{ is frictional loss}$$

$H_d$  is delivery loss.

Now,

$$H_d = \frac{v d^2}{2 g}$$

i.e. = 0.16 m

and

$$H_f = \frac{4 f L V_s^2}{2 g D_s}$$

Here the frictional loss in delivery pipe is neglected for its shorter length as compared to the suction pipe.

hence,

$$H_f = 0.0004 \times L \text{ m}$$

$$H_m = 2.16 + 0.0004 L$$

For the pipe length of 5000 m,

$$H_m = 4.16 \text{ m}$$

Hence, cooling water pump power,

$$P_w = 0.010 \text{ MW.}$$

------(7)

6. Power plant efficiency (Ng),

$$N_g = \frac{\text{Net output energy}}{\text{Input energy}}$$

Input energy is the total of (5), (6), (7) and heat input.